

Together  
we move  
the  
world.

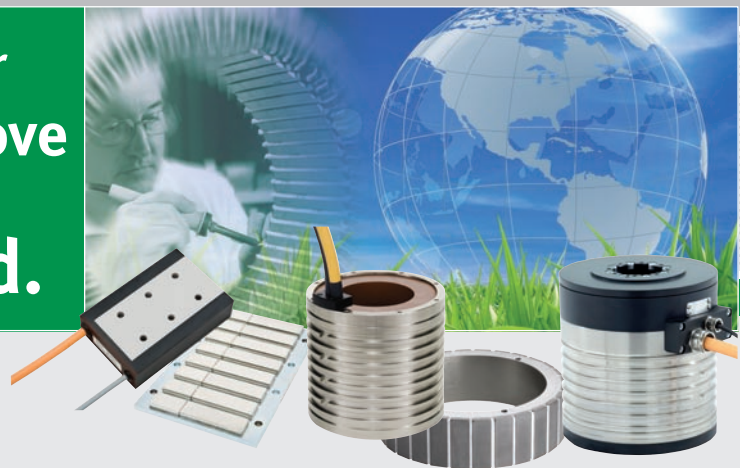

- **IDAM Direct Drives**

The perfect solution for every application  
anywhere in the world.



# IDAM, INA – Drives & Mechatronics

## Your partner for direct drive technology.

INA – Drives & Mechatronics GmbH & Co. KG, a member of the Schaeffler Group, is a specialist in direct drive technology. High precision, dynamic performance and a wide range of possible applications make this technology incredibly unique.

INA – Drives & Mechatronics GmbH & Co. KG's (IDAM) products include linear, rotary and two-coordinate direct drives with a wide variety of sizes and performance levels as well as the electronic components necessary for their operation. IDAM specialises in efficient torque motors as well as customer-specific high-performance multi-axis systems.

IDAM's cutting-edge direct-drive positioning systems are the result of joint development projects and interdisciplinary collaboration between IDAM, INA and FAG.

IDAM has extensive experience in the following industries: machine tools and production machinery, automation technology, productronics, measuring technology and medical engineering, food and beverage and packaging.

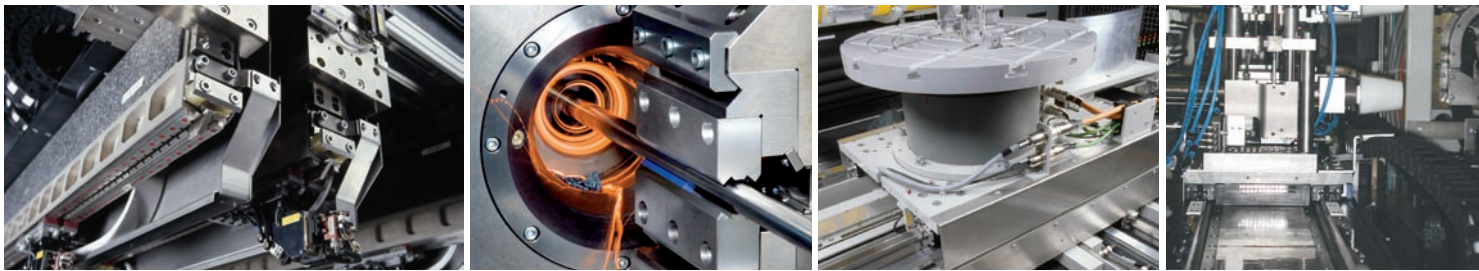

### 1 Precision.

A direct drive generates force, torque and motion without conventional gears. This eliminates the need for clutches, spindles or other converters.

For dynamic and high-precision applications, eliminating transmission components offers significant advantages over conventional drives.

In short: Direct drives can boost productivity in a way that conventional drive systems cannot. All IDAM direct drives have six main features that improve quality assurance and boost efficiency at the same time.

### 2 Dynamic performance.

Twenty years ago, IDAM engineers began developing motors and systems for the highly innovative and demanding productronics market.

Today, our employees have extensive experience with applications in a wide range of industries. Our strengths come into play wherever today's new products test the technological limits of mechanical engineering and tool building applications.

### 3 Flexibility.

### 4 Safety.

### 5 Compactness.

### 6 Energy efficiency.

# Know-how & Expertise.



Linear  
Direct Drives.



Rotary  
Direct Drives.



Electronic  
Components.



System  
Solutions.



## Advantages of direct drives

### 1 Precision:

Positioning accuracy in the nanometre range | Excellent synchronisation capabilities | Minimal radius/path deviation | Precise positioning without reversing backlash | High static and dynamic load rigidity

### 2 Dynamic performance:

High accelerations | High final speeds

### 3 Flexibility:

Program-controlled functionality and retooling | Multi-forcer and multi-coordinate systems | Easy to combine with guide elements | Few components | Minimal installation and adjustment

### 4 Safety:

Wear-free, consistent precision over the entire life cycle | Overload protection for motor and machine | Reduced number of system components

### 5 Compactness:

Compact designs | Easy to integrate into existing designs

### 6 Energy efficiency:

Highly efficient | Energy-saving potential



*Thanks to their innovative features developed in-house, IDAM direct drives are on the cutting edge of technology and are the perfect solution for every application. Customised, high-performance complete systems give you a competitive edge. Choose IDAM if your goal is a profitable product. The following is an overview of our core expertise.*



# Linear Motors

## Highly dynamic and efficient.

The extensive IDAM range of linear direct drives offers the perfect solution for almost any requirement.

Applications – from highly dynamic to extremely precise ones – are optimised through use of our linear motors.





The diverse motor series are attractive due to their compactness, power density and advantageous price-performance ratio.

When used correctly, IDAM direct drives provide a great deal of benefits compared to traditional drives with regard to keeping energy consumption low whilst achieving higher levels of performance.

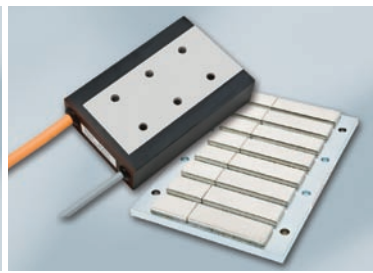
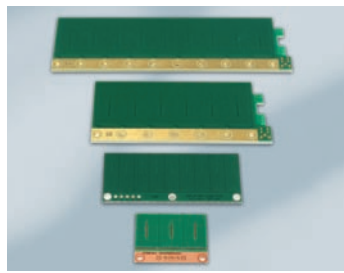
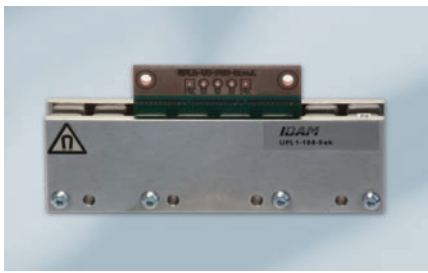
The UPL series is a highlight of the IDAM linear range. These drives feature maximum path precision, compact designs and are easily adapted to custom solutions.

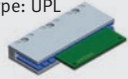
These applications range from a „fine-tuned“ and dynamic voice coil for bond applications, to high-precision axes in measuring and processing machines to quick handling axes.

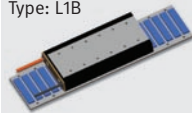

Motor type	Features	Design
<b>Ironless motors</b> UPL series	PCB-based   efficient   low-cost   compact   $F_p$ up to 200 N	Type: UPL 
ULIM series	Highly dynamic   no cogging   $F_p$ up to 2500 N   2-/3-phase	Type: ULIM 
<b>Slotted motors</b> L1 series	L1A: $F_p$ up to 1000 N   optimum power-to-weight ratio L1B: $F_p$ up to 1500 N   optimised heat loss L1C: $F_p$ up to 5100 N   optimised heat loss   water-cooled	Type: L1B 
L2U series	Double-sided motor   efficient   dynamic   $F_p$ up to 12000 N	Type: L2U 
<b>Special motors</b> LRAM Moving Coil Moving Magnet	Holding force: 10 N to 400 N   resolution: 1 – 3 $\mu$ m   air bearing Force: 12.5 N bis 18 N   single-phase voice coil motor Force: 50 N   single-phase plunger motor (moving magnet)	Type: LRAM 

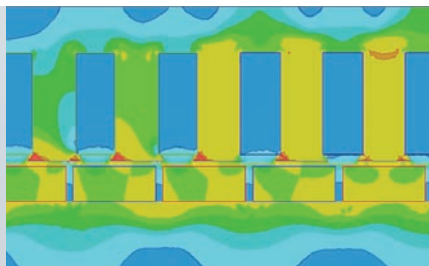
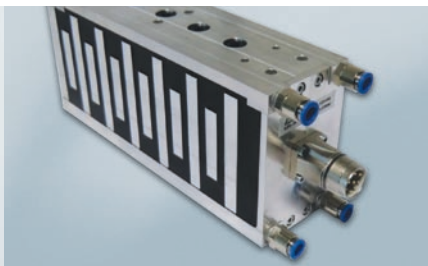
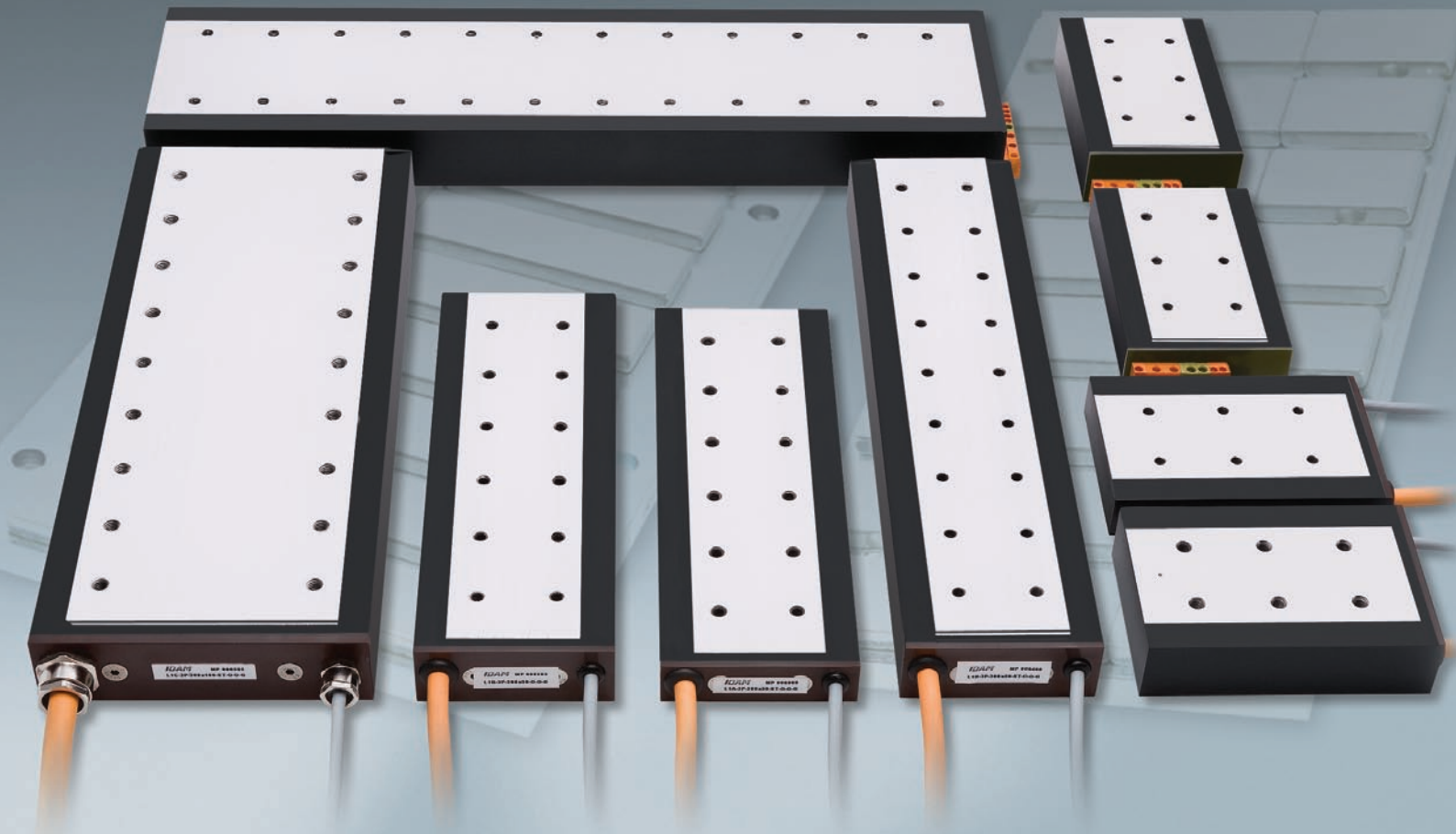

## Benefits

- Highly dynamic motors thanks to excellent power-to-weight ratio
- Precise positioning and even motion allows for zero cogging and minimal load pulsation
- Efficient performance cooling / precision cooling for maximum power density
- Monitoring of motor temperature
- Maximum reliability thanks to cutting-edge manufacturing and testing technologies
- Use of high-energy magnets from 100% controlled production facilities for maximum service life, even under difficult operating conditions

## Applications

Handling systems, pick and place applications, machines for circuitry production, measuring machines, machines for visual inspections, laser cutting, milling and grinding machines, packaging machines, plotters with direct laser imaging, machine tools



The single-phase moving coil and moving magnet linear motors operate like an electrodynamic system. They are designed for positioning or oscillatory motion within a range of a few millimetres.

+

# Torque Motors

## Powerful and reliable.

The current generation of torque motors display outstanding, unprecedented performance characteristics. These are achieved through the optimum combination of the appropriate bearing and the required measuring system. IDAM recommends different motor types for specific applications, which are perfect with regard to torque, synchronisation and design.

Rotary direct drives made by IDAM form the foundation for constructing the most powerful rotary axis in the world. IDAM torque motors are ideal for mechanical engineering applications where high torque and optimum synchronisation are required.

Maximum power output is ensured by the highly efficient, closed cooling system.



Motor type	Features	Design
<b>Ironless motors</b> UPR types	High-performance and low cost   PCB-based   customer-specific   dynamic   precise   highly efficient	Type: UPR 
<b>Slotted motors</b> RI/RE series	Internal/external rotor   high torque up to $\varnothing$ 1030 mm   $T_p$ up to 15000 Nm, on request up to 100000 Nm   minimal cogging	Type: Internal rotor 
RKI series	High-performance internal rotor   up to 30% more torque   up to 4 times greater speeds compared to conventional motors   customer-specific	Type: External rotor 
HSRV/SRV types	Internal rotor   high speed, up to 50 m/s circumferential speed   spindle applications   customer-specific   minimal cogging	
<b>Slotless motors</b> RMK/RMF types	Customer-specific or integrated motors   zero cogging at any diameter up to 2500 mm   for circumferential speeds of up to 15 m/s	Type: RMK Type: RMF 

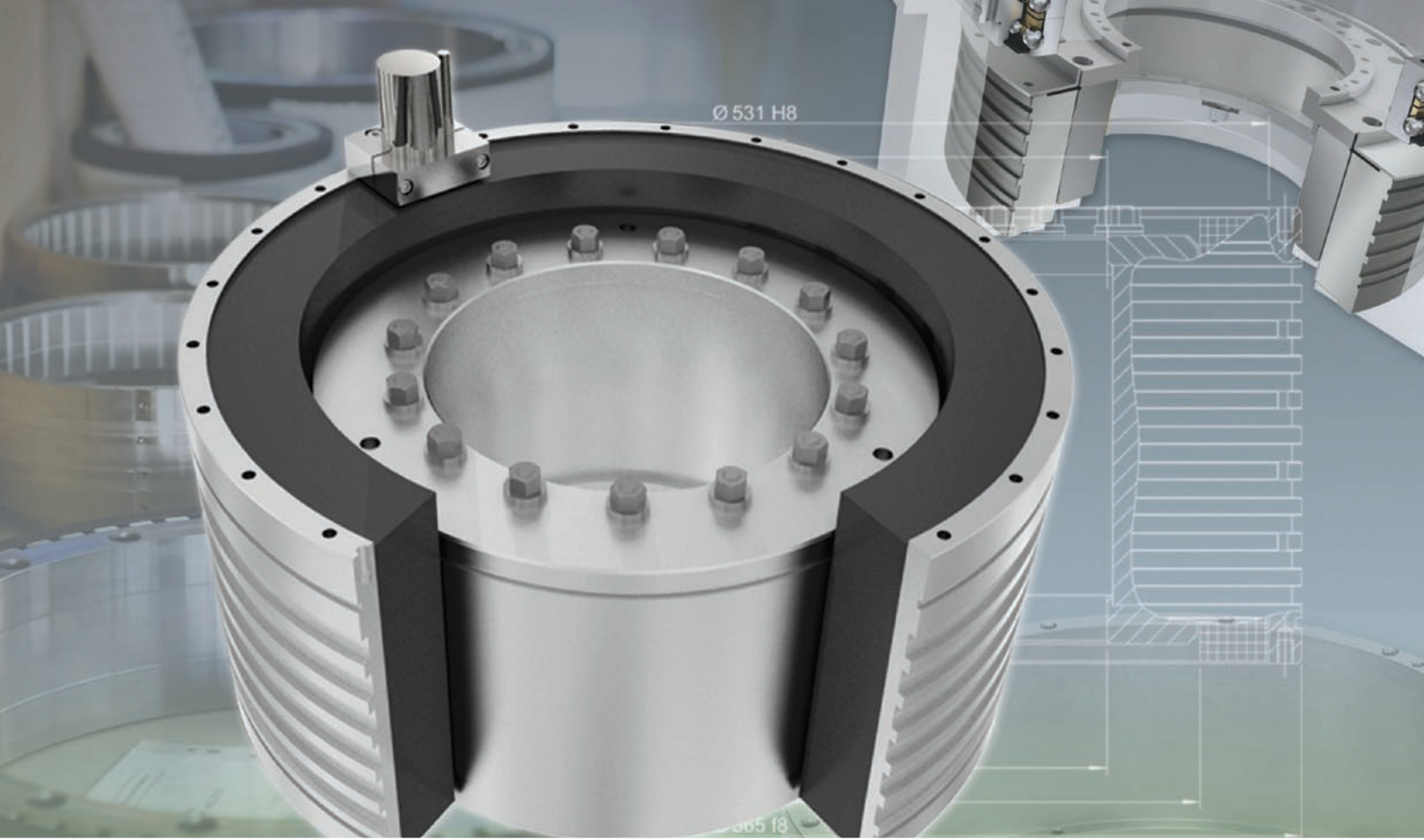

### Goal: Perfection

IDAM is opening up new areas of application with the high-performance series of RKI rotary drives. Thanks to the innovative design of these drives, they offer outstanding motor constant values.

These drives achieve high torque and high speeds with minimal heat generation, thereby offering maximum performance, cost-effectiveness and energy efficiency.

Compared to standard internal rotor motors:

- +30% more torque
- +400% more speed
- +500% more mechanical performance
- -60% less heat loss

### Your advantage: Tailored drives

Since off-the-shelf solutions do not cover the full range of possible applications, IDAM makes custom drives based on tested magnet systems. Their segment-based design offers maximum efficiency, allows for high speeds and easy maintenance.

Each segment generates a feed force according to the height of its magnet. This height can be varied between 25 mm and 200 mm in 25 mm increments so that the smallest segment generates approximately 560 N and the largest generates 4500 N.





# Planar Systems and Electronics

## Precise and flexible.

The air-bearing planar drive is a two-coordinate direct drive. It is ideal for combining motors, measuring systems and guides for two coordinates in one plane. A simple and rugged design results in high precision and dynamic performance (2 m/s, 33 m/s<sup>2</sup>). Years of wear-free use combined with several freely programmable rotors in one plane make this drive excellent value for money.

A planar drive can also be operated vertically and upside down.

Depending on the application, users can choose between simple stepper motor control systems or position-controlled servo systems.

Planar drives are excellent for positioning tasks in mechanical engineering and tool building.

„Simple” point-to-point positioning and complex interpolated path movements are possible.

In addition to compact standard motors, the drives can be modified for special applications such as backlight tables.

Thanks to compact high-performance electronics and a universal soft PLC, this drive system is excellent for complex automation tasks.

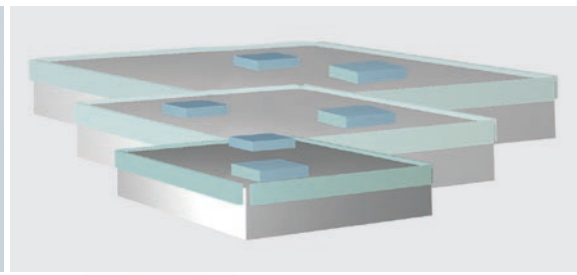
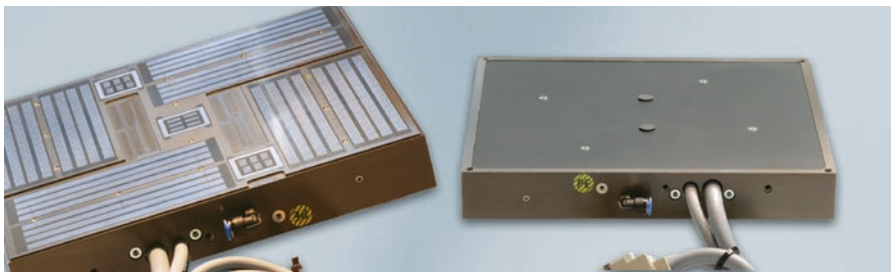

### Technical features

Maximum stator size	1500 x 1000 mm
Force	130 N
Speed	2 m/s
Repeat accuracy	±1 µm
Absolute accuracy	±8 µm

### Benefits

- Easy construction of X/Y motion systems
- Scalable motion range and number of rotors
- Low height as all axes are in one plane
- Free choice of installation position in space
- Can be combined with other axes
- Use of state of the art, standardised control technology
- Lightweight construction thanks to use of compound materials (140 kg/m<sup>2</sup>)
- Excellent accuracy in terms of parallelism, flatness and position across entire motion range
- Twist correction (phi) of rotors possible





### Applications

Particularly suitable for efficient implementation of applications in:

- Automation
- Micro-assembly
- Laser technology
- Laboratory technology
- Pressure application
- Measuring and testing applications





Electronic components	Features	Design
Digital Motor Drive: DMD-078.12	<ul style="list-style-type: none"> <li>Integrates output stages for 8 single-phase motors, 4 two-phase motors or 4 three-phase motors, or combinations of these in one device</li> <li>Digital current control</li> <li>2 x 3 encoder inputs</li> <li>Oversampling and more</li> <li>Field bus: EtherCAT®</li> </ul> $24 - 120 V_{DC} \mid I_N = 8 \times 7 A_{rms} \mid 20 \text{ kHz PWM}$	
Interpolators IP0550 IP-HBK01 IP-HBK10	<ul style="list-style-type: none"> <li>For <math>1 V_{pp}</math> sin/cos input signals</li> <li>Output: RS422 (adjustable frequency)</li> </ul> IP factor 5 ... 50 x   analogue input, 400 kHz IP factor 5 ... 50 x   analogue input, 400 kHz IP factor 25 ... 250 x   analogue input, 100 kHz	



# Linear and Rotary Systems

## Compact and powerful.

IDAM develops innovative and powerful solutions for rapid, precise positioning and handling tasks, which guarantee efficient results due to their direct drives. IDAM sets standards in terms of precision. The highest levels of accuracy right down to the sub-micrometre range are achieved – even when movement is resisted by a load – due to very high rigidity in the servo loop.

Maximum accelerations (up to 1000 m/s<sup>2</sup>) and final speeds allow for a highly dynamic performance and shorter production cycles.

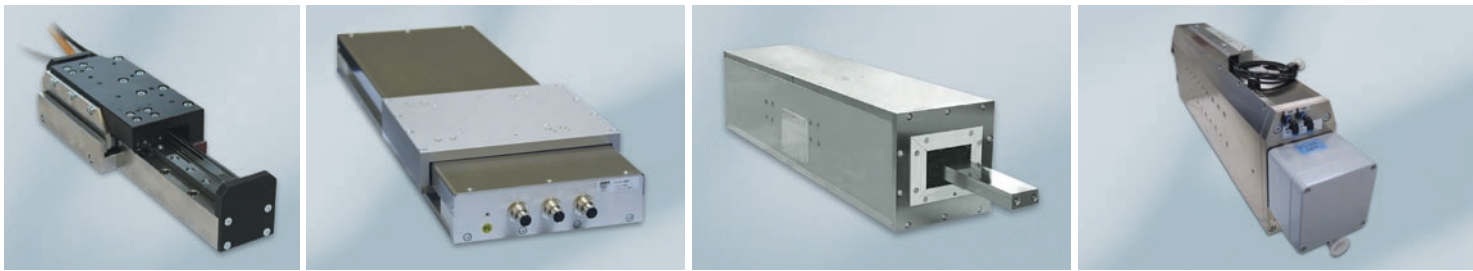

### Linear systems

Linear systems from IDAM meet the highest standards of accuracy and dynamics. Their compact design and high power density are equally captivating. Our customer development partnerships and continuous interdisciplinary collaboration within the Schaeffler Group lead to high-performance systems. In this way, innovative mechatronic solutions are created, enabling completely new concepts. A system formed of a motor and guide, ready to install, perfectly tuned and all from one source.

### Benefits

- High dynamic performance
- High precision
- Excellent synchronisation
- Very good acceleration
- High speeds
- Compact design
- Easy installation
- Very good static and dynamic load rigidity
- Low levels of wear and maintenance

### Applications

- Pick and Place
- Electronics and packaging industry
- Short stroke applications
- Handling and transport systems
- Automation technology
- Assembly systems
- Wafer positioning
- Test and control applications

Linear systems in various designs: short-stroke axis, push rod or linear axis. Economical and reliable. Try it out yourself!

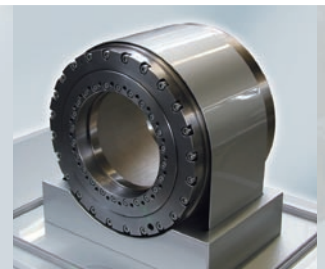
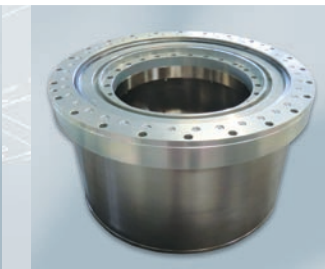
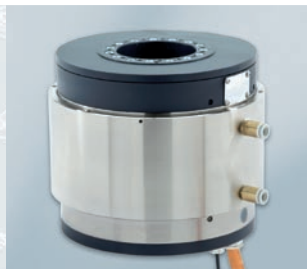
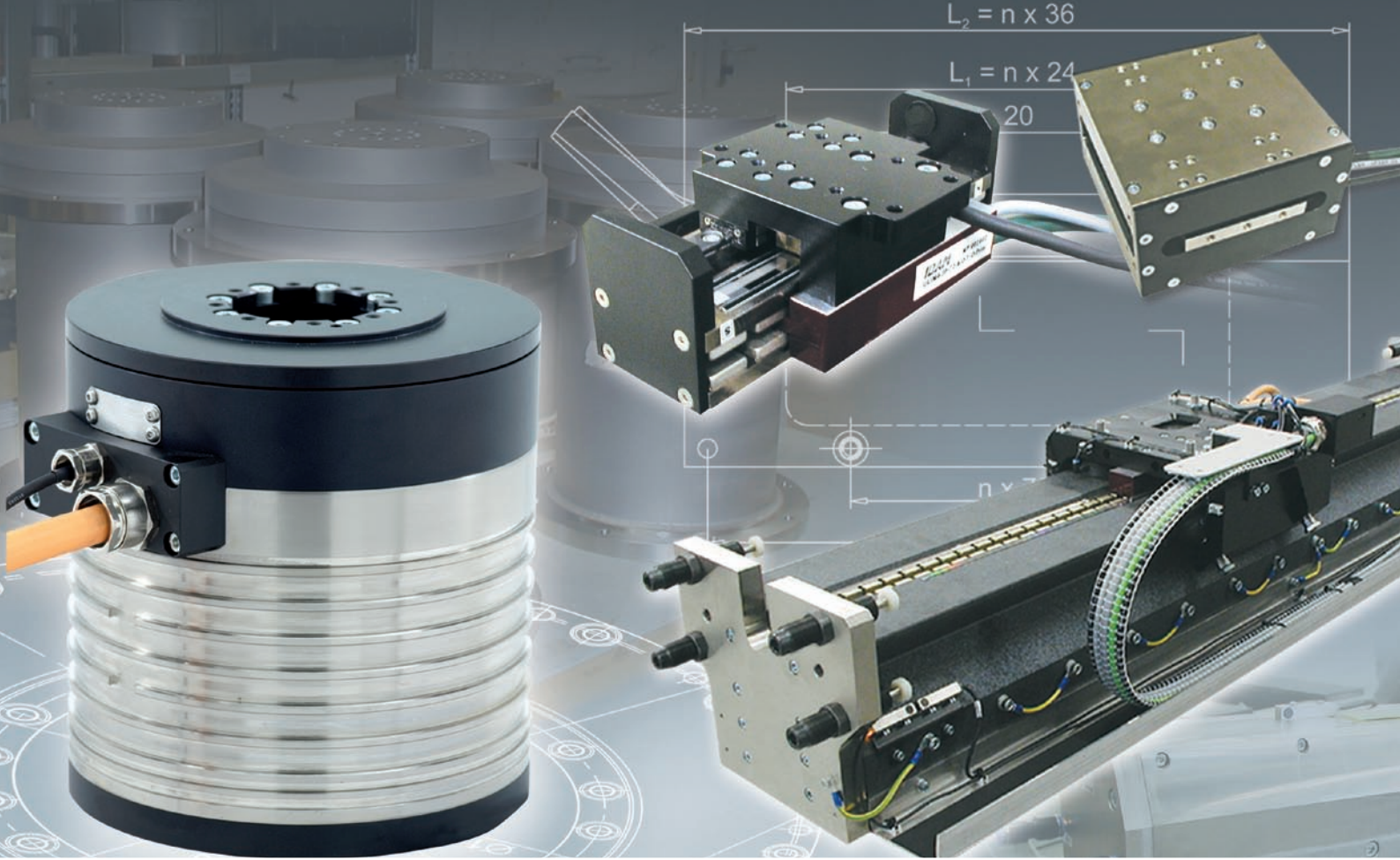

## Rotary systems

The RDDS1 standardised rotary table range includes rotary direct drive systems with diameters of 130, 160, 180 and 230 mm with four height levels each and maximum torques between 9 Nm and 369 Nm. To meet the special requirements of the automation, measuring and productronics industries, these drives were designed with highly reliable stalling torques as well as high load carrying capacity, rigidity, accuracy and dynamic performance.

IDAM designs customer-specific, optimised systems for a wide range of applications. These systems meet today's more demanding requirements for precision and efficiency.

## Benefits

- Highly dynamic and high rigidity
- Excellent synchronisation characteristics
- Extremely fast acceleration
- High speed
- Compact design
- Easy installation
- Very good static and dynamic load rigidity
- Positioning without reversing backlash
- Minimal wear and maintenance
- Minimal rotor inertia

## Applications

- Rotary indexing tables
- Positioning tables for point-to-point applications
- Test and control tables
- Robot kinematics
- Handling and feed axes in automation technology
- Laser industry
- Pick and place machines

+

# Customer-Specific Multi-Axis Systems

## Individually tailored and innovative.

As a motor specialist, INA – Drives & Mechatronics GmbH & Co. KG collaborates with customers to create new performance-oriented system solutions that use direct drives to guarantee better value for money.

Simulations are used to determine the best options and the appropriate type of direct drive technology. The IDAM team then develops and implements customer-specific solutions that are integrated into the existing overall system.

Using the appropriate INA/FAG guide/bearing assemblies and native sensor systems, IDAM offers tailored engineering systems that feature outstanding functional integration.

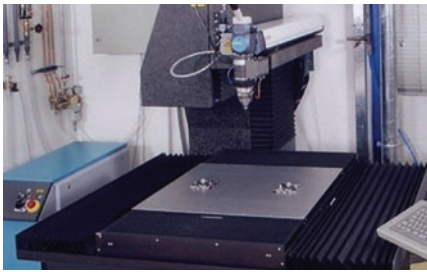

High-precision system with clamping device for precise laser machining

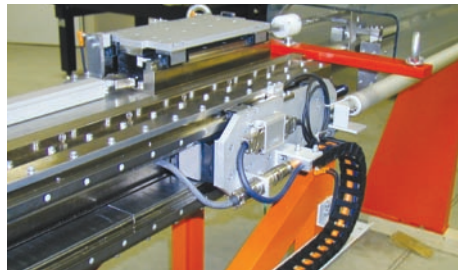

High-speed multi-axis system for pick and place



Precision X/Y stage system for optical scanning

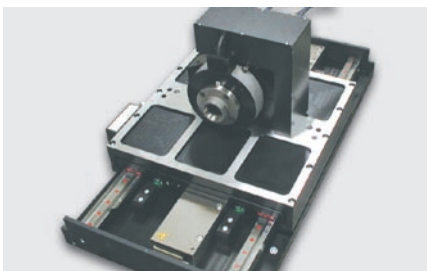

Two-axis positioning system for the productronics industry

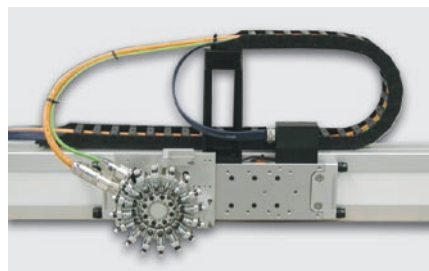

Two-axis positioning system for the productronics industry

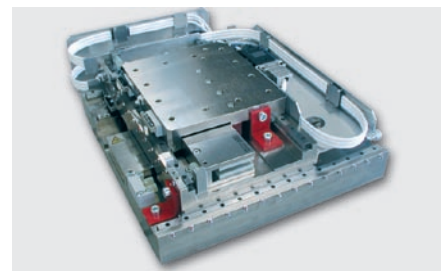

Dynamic handling system for fine cutting presses

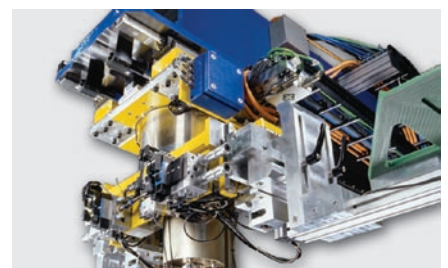
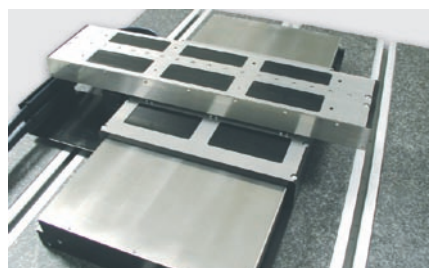
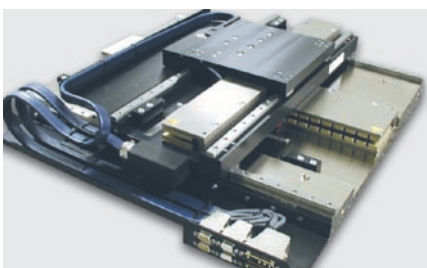

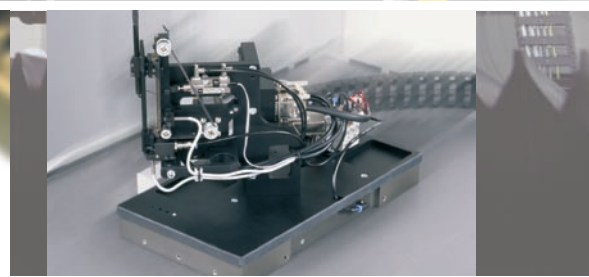
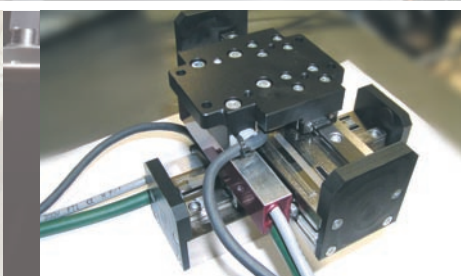
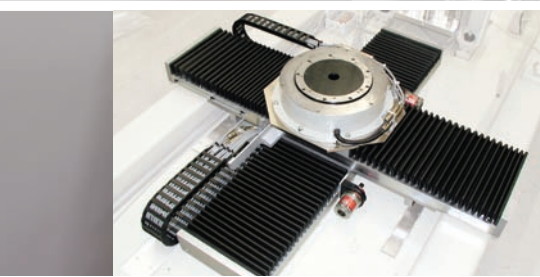
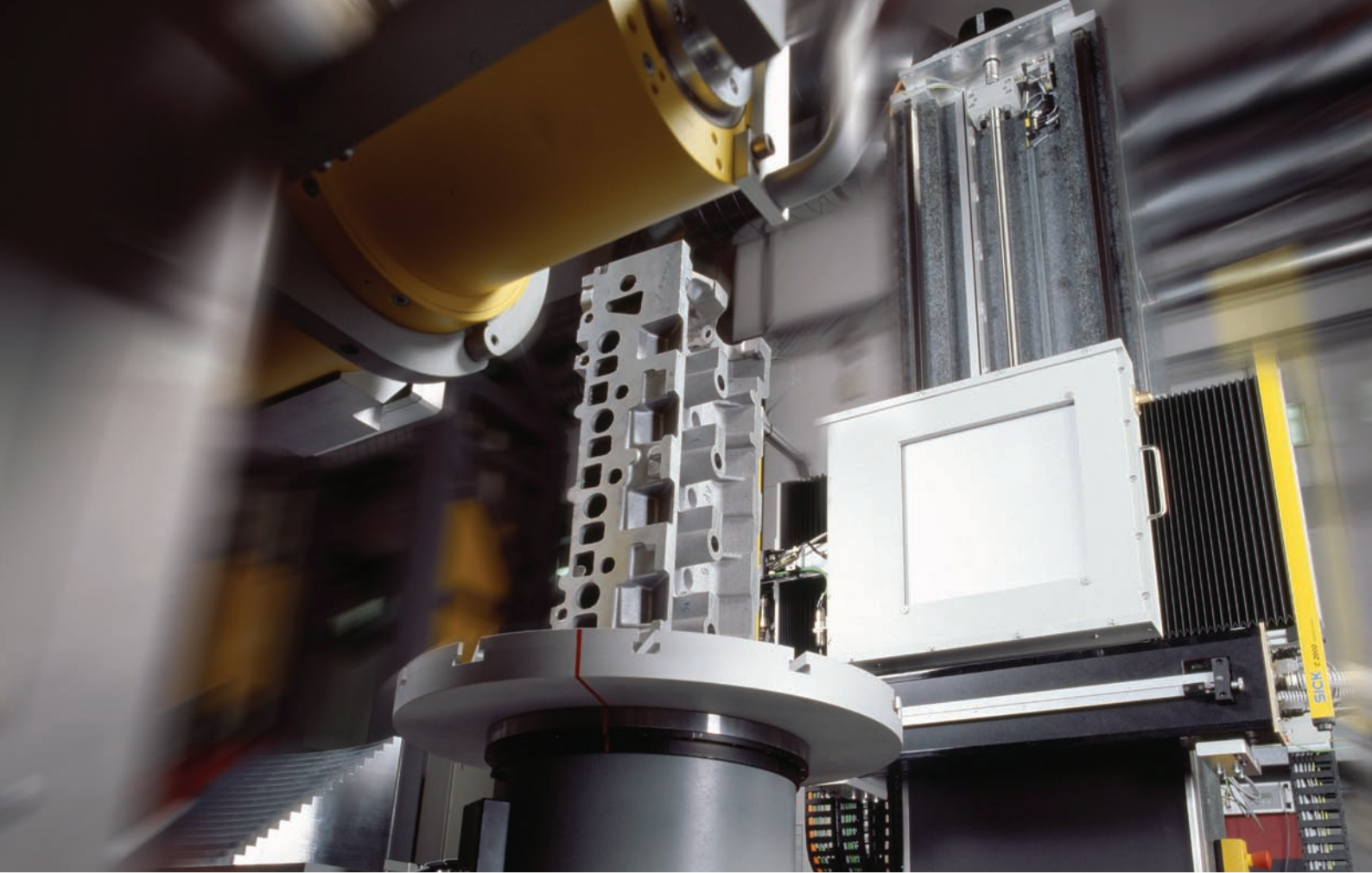

Fully automated multi-layer measuring and drilling system

5-axis manipulator for an X-ray measuring machine

Dynamic multi-axis system for the printing industry

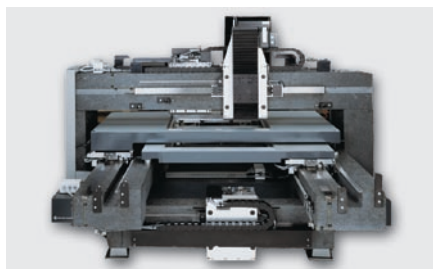

Open frame backlight table for industrial productronics

Air-bearing high-precision stage for rapid fine finishing

Compact, high-precision X/Y stage for PCB/flat panel production

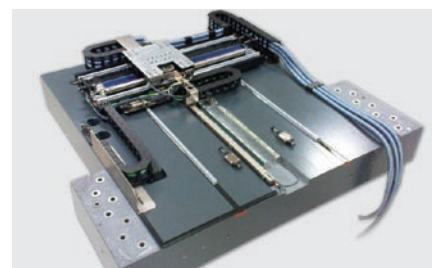
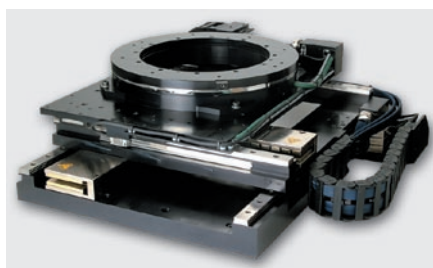

+

# Technical Information and Advice

## Knowledgeable and competent.

Are you interested in detailed technical information?

We would be happy to send you our product brochures. Contact us: [idad@schaeffler.com](mailto:idad@schaeffler.com)

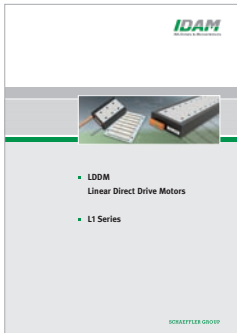

LDDM – Linear Direct Drive Motors: L1 Series



LDDM – Linear Direct Drive Motors: L2U Series

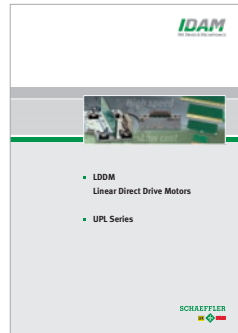

LDDM – Linear Direct Drive Motors: UPL Series

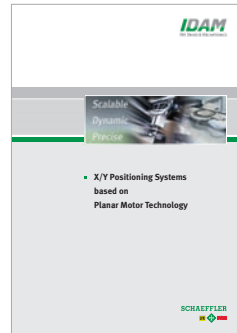

X/Y Positioning Systems based on Planar Motor Technology

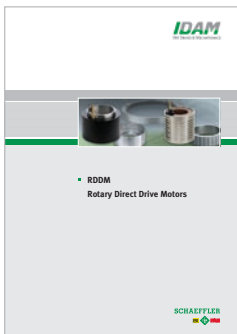

RDDM – Rotary Direct Drive Motors

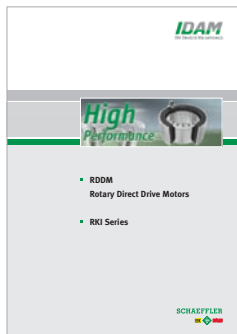

RDDM – Rotary Direct Drive Motors: RKI Series

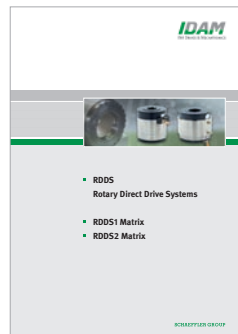

RDDS – Rotary Direct Drive Systems: RDDS1, RDDS2 Matrix

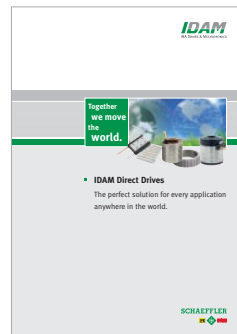

Product Overview: IDAM Direct Drives

We would be happy to provide you with product brochures for our electronic assemblies and system solutions.

All information about our motors and systems can also be found on our website at [www.idam.de](http://www.idam.de).

IDAM offers you cutting-edge technology and expert advice. The IDAM application technicians will be happy to help you select the perfect drive for your application. Get in contact with us. Phone: +49 3681 7574-0

**Automation/medical engineering**  
E-mail: [idad.automation@schaeffler.com](mailto:idad.automation@schaeffler.com)

**Productronics/measuring technology**  
E-mail: [idad.productronic@schaeffler.com](mailto:idad.productronic@schaeffler.com)

**Production machinery/heavy industries**  
E-mail: [idad.pm@schaeffler.com](mailto:idad.pm@schaeffler.com)

**Automotive**  
E-mail: [idad.automotive@schaeffler.com](mailto:idad.automotive@schaeffler.com)

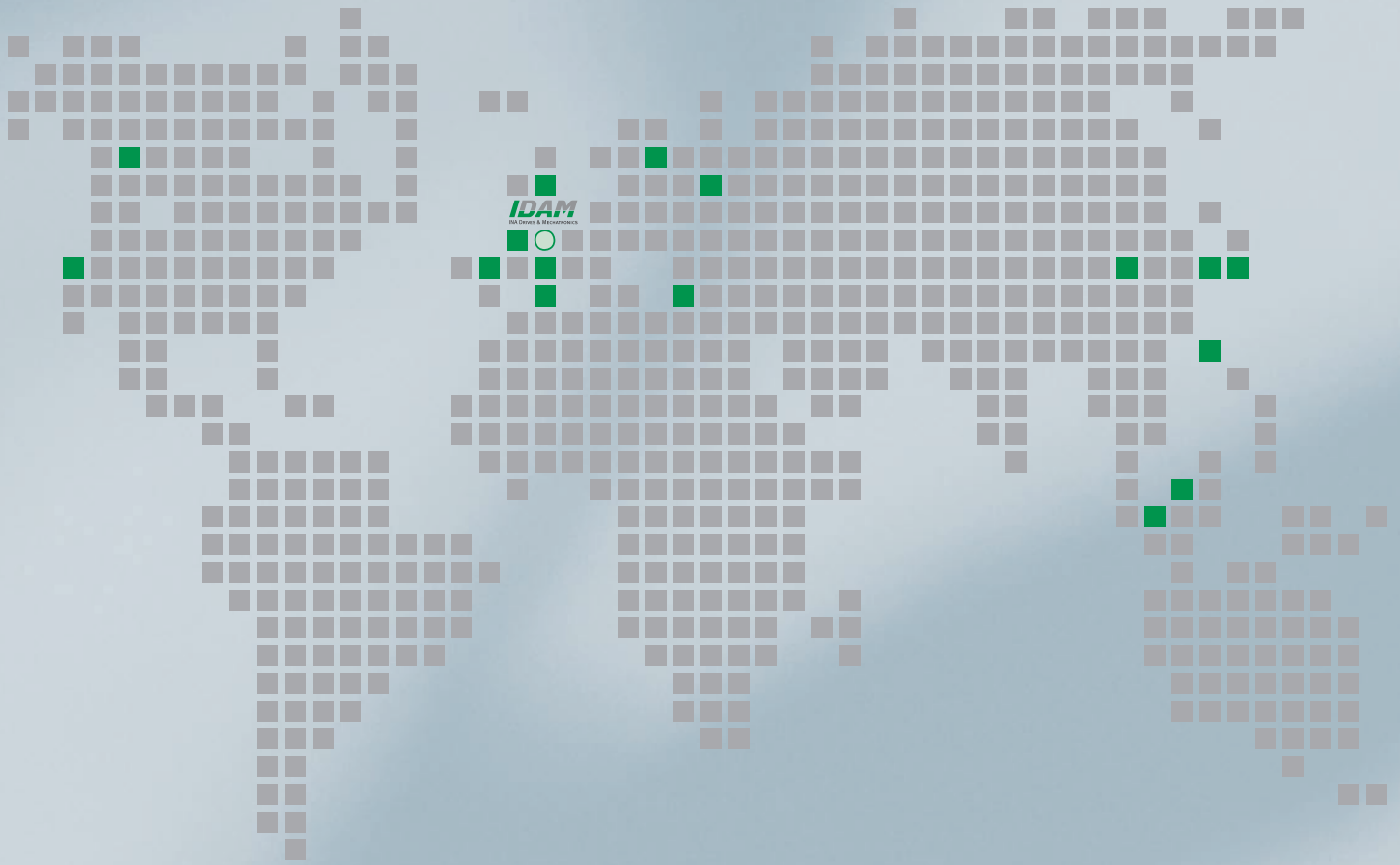

## ***IDAM worldwide.***



### **Austria**

Phone: +43 2672 2023332

E-mail: [idam.austria@schaeffler.com](mailto:idam.austria@schaeffler.com)

### **Canada**

Phone: +780 980 3016

E-mail: [idam.canada@schaeffler.com](mailto:idam.canada@schaeffler.com)

### **China**

Phone: +86 21 39576465

E-mail: [idam.china@schaeffler.com](mailto:idam.china@schaeffler.com)

### **Finland**

Phone: +358 207 366238

E-mail: [idam.finland@schaeffler.com](mailto:idam.finland@schaeffler.com)

### **Israel**

E-mail: [idam.israel@schaeffler.com](mailto:idam.israel@schaeffler.com)

### **Italy**

Phone: +39 0321 929267

E-mail: [idam.italia@schaeffler.com](mailto:idam.italia@schaeffler.com)

### **Japan**

Phone: +81 45 274 8302

E-mail: [idam.japan@schaeffler.com](mailto:idam.japan@schaeffler.com)

### **Korea**

Phone: +82 2 311 3096

E-mail: [idam.korea@schaeffler.com](mailto:idam.korea@schaeffler.com)

### **Netherlands**

Phone: +31 342 403208

E-mail: [idam.nederland@schaeffler.com](mailto:idam.nederland@schaeffler.com)

### **Russia**

Phone: +7 495 7377660

E-mail: [idam.russia@schaeffler.com](mailto:idam.russia@schaeffler.com)

### **Singapore/Malaysia**

Phone: +65 6540 8683

E-mail: [idam.singapore@schaeffler.com](mailto:idam.singapore@schaeffler.com)

### **Spain/Portugal**

Phone: +34 93 4803679

E-mail: [idam.iberia@schaeffler.com](mailto:idam.iberia@schaeffler.com)

### **Switzerland**

Phone: +41 71 4666312

E-mail: [idam.schweiz@schaeffler.com](mailto:idam.schweiz@schaeffler.com)

### **Taiwan**

E-mail: [idam.taiwan@schaeffler.com](mailto:idam.taiwan@schaeffler.com)

### **United Kingdom**

E-mail: [idam.uk@schaeffler.com](mailto:idam.uk@schaeffler.com)

### **USA**

Phone: +1 704 5167517

E-mail: [idam.usa@schaeffler.com](mailto:idam.usa@schaeffler.com)

### **Other countries:**

E-mail: [idam.sales@schaeffler.com](mailto:idam.sales@schaeffler.com)



**INA – Drives & Mechatronics GmbH & Co. KG**

Mittelbergstrasse 2  
98527 Suhl, Germany

Phone +49 3681 | 7574-0

Fax +49 3681 | 7574-30

E-mail [idad@schaeffler.com](mailto:idad@schaeffler.com)

Web [www.idam.de](http://www.idam.de)

